

Hall sensors

MTRM 16G2524/M100

dimension drawing

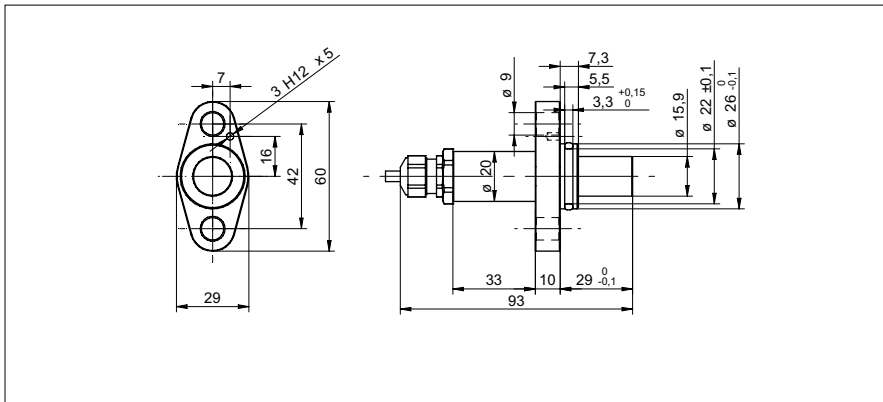

general data

version	full metal
sensor type	differential hall sensor
working distance max.	1,0 mm (module 1)
min. gear size	module 1
gear width	> 10 mm
gear material	ferromagnetic
gear shape	involute gear (DIN867)

electrical data

switching frequency range	2 ... 20 kHz
voltage supply range +Vs	8 ... 28 VDC
current consumption max. (no load)	20 mA
output A	push-pull
output B	push-pull
output current	< 30 mA
voltage drop Vd	< 5 VDC
short circuit protection	yes
reverse polarity protection	yes, Vs to GND
insulation resistance (at 500 VDC)	> 100 MΩ
leakage current (at 500 Veff AC)	< 0,5 mA

mechanical data

type	cylindrical, with flange
housing material	brass nickel plated
dimension	16 mm
housing length	93 mm
installation aid	pin hole
connection types	cable Radox, 2 m
front of sensor durable against pressure	20 bar

ambient conditions

operating temperature	-40 ... +120 °C
protection class (sensing face)	IP 68
protection class (sensor)	IP 67

photo



connection diagram

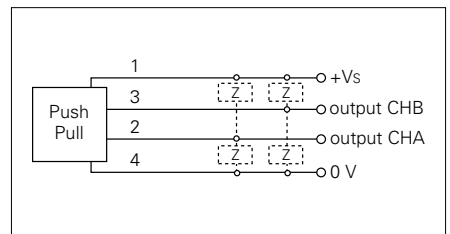

output signal

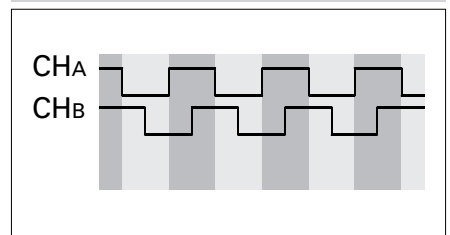

- Fulfilled standards:
EN 50155:2007 (class S1)
EN 50121-3-2:2006 tables 7,8,9
EN 61373:1999 (cat. 3)

- Fire protection (cable): CEN/TS 45545